

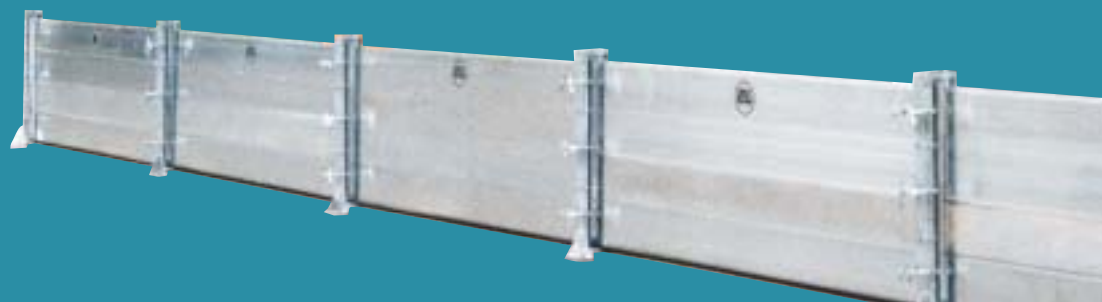

## *Flood Water Barriers – Inflow Protection*

*Flood Protection Barrier BL-HWS-K*



# *Blobel Environmental Engineering*

## ***Blobel Environmental Engineering State of the Art Flood Protection Systems***

In recent years, we have experienced more and more extreme weather conditions which have caused severe environmental damage and devastation.

BLOBEL has reacted to this trend. For over 10 years we have been a leading European business in the containment of contaminated fire fighting water and spill control. By developing simple and effective flood protection systems, both permanent and mobile, we have set standards in the market. The operating and sealing technologies we have implemented are now the basis of many new products in the market. Our flood protection systems are internationally approved.

On-site engineer consultation, installation and after sales service are, of course, part of our overall package.

### ***Flexible and Reliable***

Whether you require fast protection from flash flooding, or walls to protect your assets from rising water, our brand products convince through simple installation and handling. Our systems incorporate advanced fast closing mechanisms and light barrier sections which are handled with ease and can be stored where limited space is available. BLOBEL Flood Protection Systems are ideal to protect private and industrial assets. Through the simple design the barriers can be universally applied for doors, gates, windows and fields. All systems can be incrementally expanded.

### ***Maximum Quality***

Our flood barriers are known for the high quality of material used and their robustness. We apply the same high safety and quality standards for our flood protection products as we do for our emergency containment systems. The sealing technology is highly chemical resistant and can safely be used with uneven floors and rendered walls. All our products are subject to continuous quality assurance measures in keeping with DIN ISO 9001.



# Product information

## BL/HWS-K

### 1. BL/HWS-K

1.1 Product description

1.2 Drawings

1.3 Electrical control unit description

1.4 Operating manual

1.5 Pneumatic and electric circuit diagrams

1.6 ISO 9001

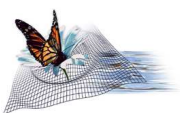
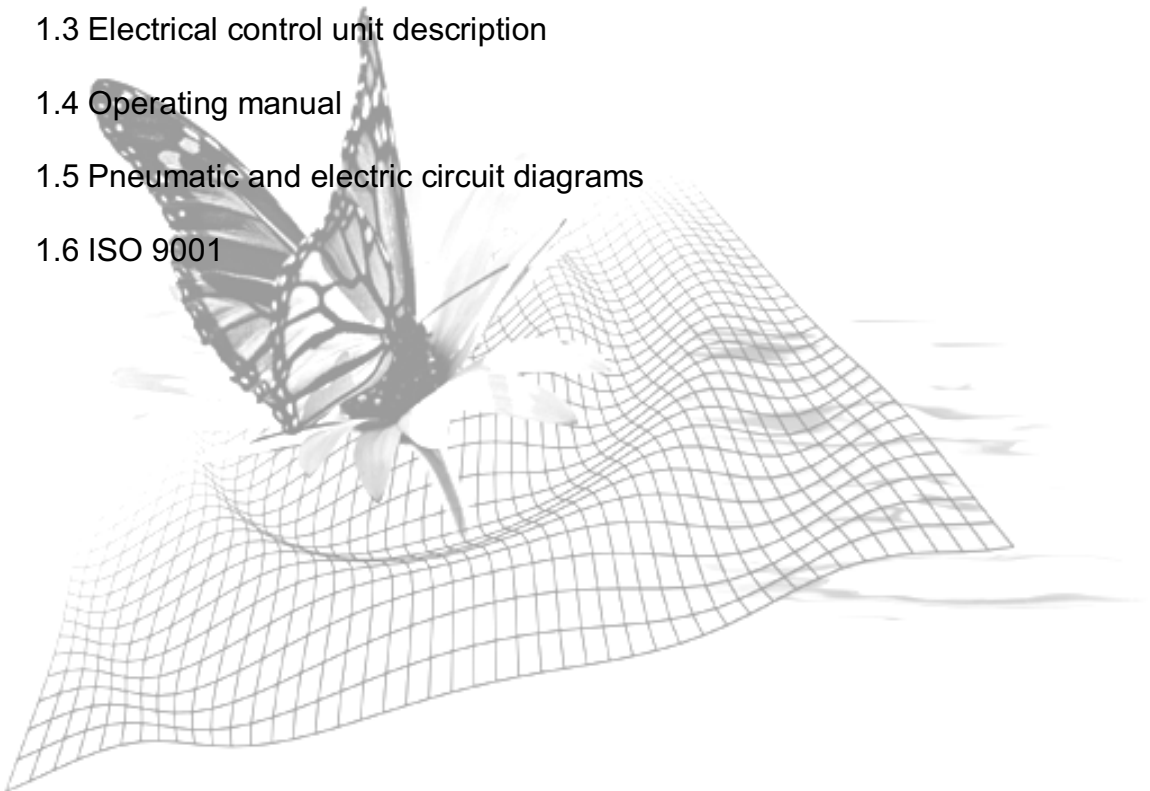

## 1. Automatic Flood Barrier BL/HWS-K

**Barrier – horizontal recessed in floor/ground  
Pneumatically controlled - fully automatic**

### Dimensions:

Standard height	100 to 1500 mm	
Special situations	up to	2000 mm
Standard length	up to	3000 mm
Special situations	up to	5000 mm

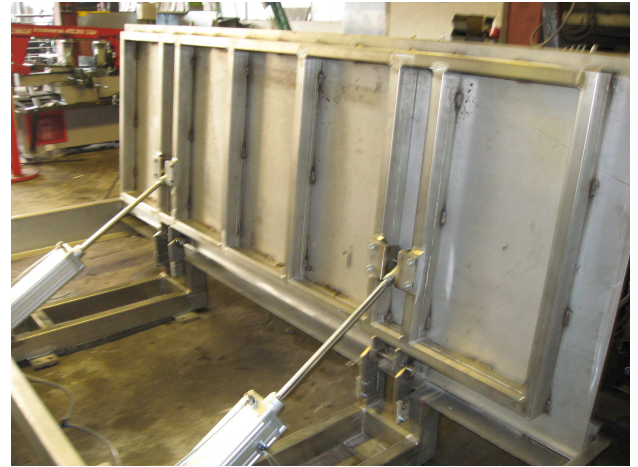

### 1.1 Description

The automatic Flood Barrier BL/HWS-K is suitable for a wide range of situations. Depending on its design it can accommodate frequent day to day traffic and heavy vehicles.

A compressible, highly durable seal is mounted horizontally within the flood barrier system. Vertical Sealing posts ensure a leak tight seal against the facility. The Flood Barrier is made from galvanised steel or stainless steel 304.

The Barrier body, firmly bolted in hinges, is reinforced and includes mounting eyes for pneumatic cylinders. The cylinders are linked to unique mounts, which are likewise securely mounted to the barrier frame. The Flood Barrier BL/HWS-K is actuated by the push

of a button or triggered automatically by an optical water sensor. The optical sensor is preset and monitors rising water levels. When actuated, the Flood Barrier closes fully automatically or travels back into the standby position. The barrier is designed to be failsafe. Loss of power or air will automatically trigger the system.

The required operating pressure is 4 - 10 bars. To meet safety requirements, the flood barrier is fitted with an acoustic warning signal. A visual warning light can be included to signal traffic or personnel that the barrier is in operation.

Pneumatic cylinders used are suitable for outdoor installations.

### Features:

- **Uncomplicated operation and variable**
- **Design-tested as basic model BED (LGA, Trade Supervision Department - Bavaria, Germany)**
- **Quality-monitored as basic model BED (LGA, Materials Testing Department - Nuremberg, Germany)**
- **Tested by the fire-fighting industry as basic model BED (IdF, Fire Brigade Institute, Heyrothsberge, Germany)**



1.2 Drawing overview

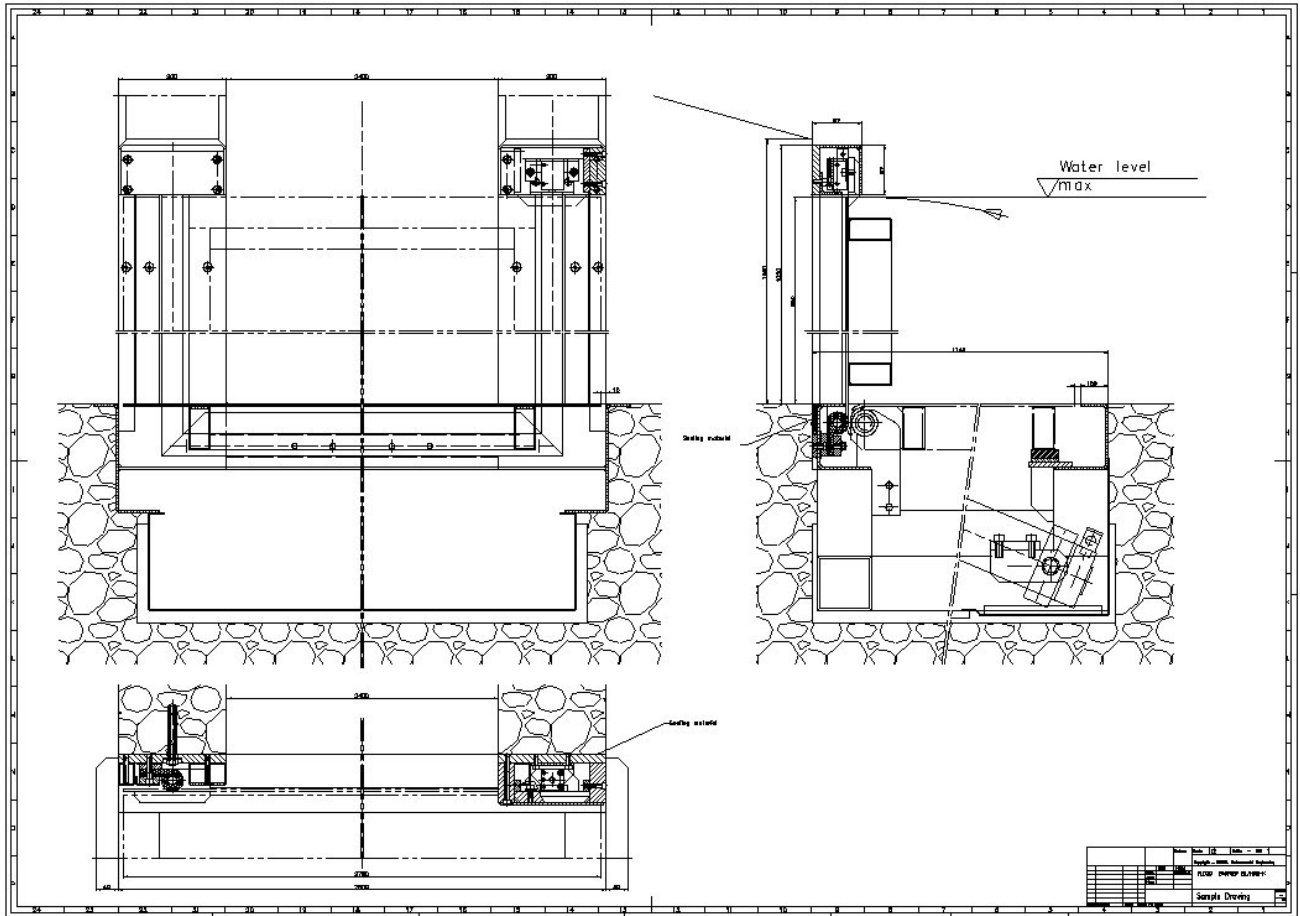



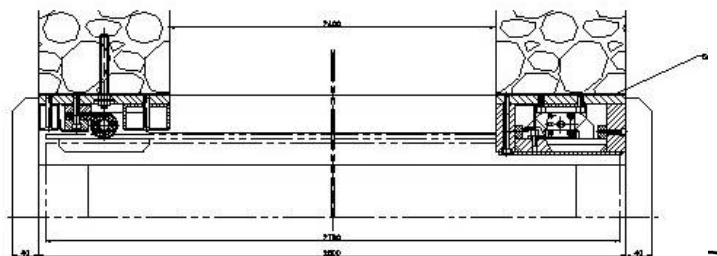
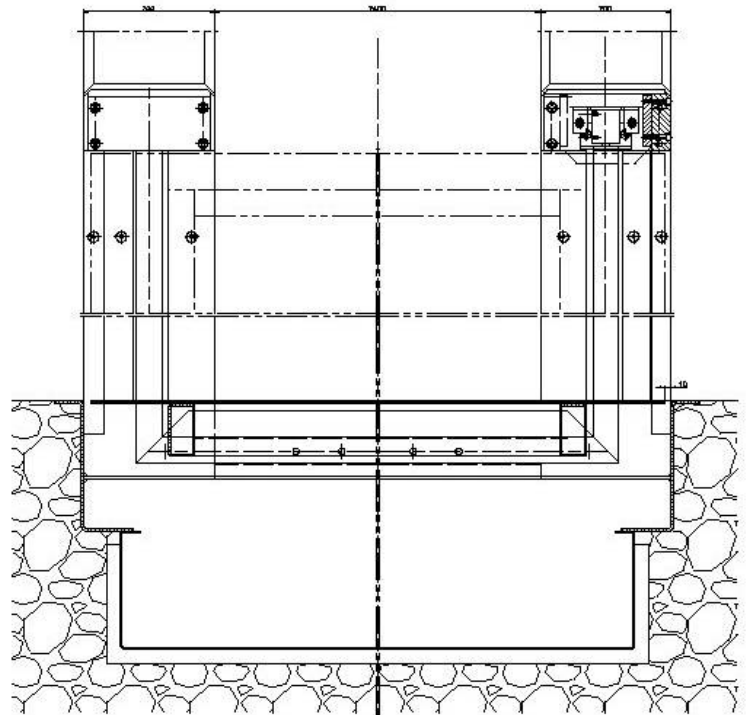
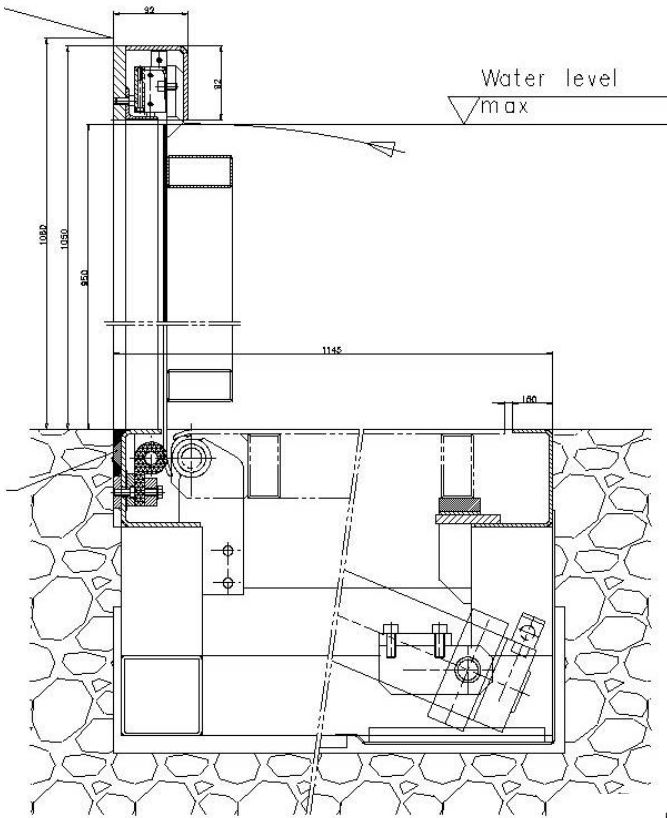

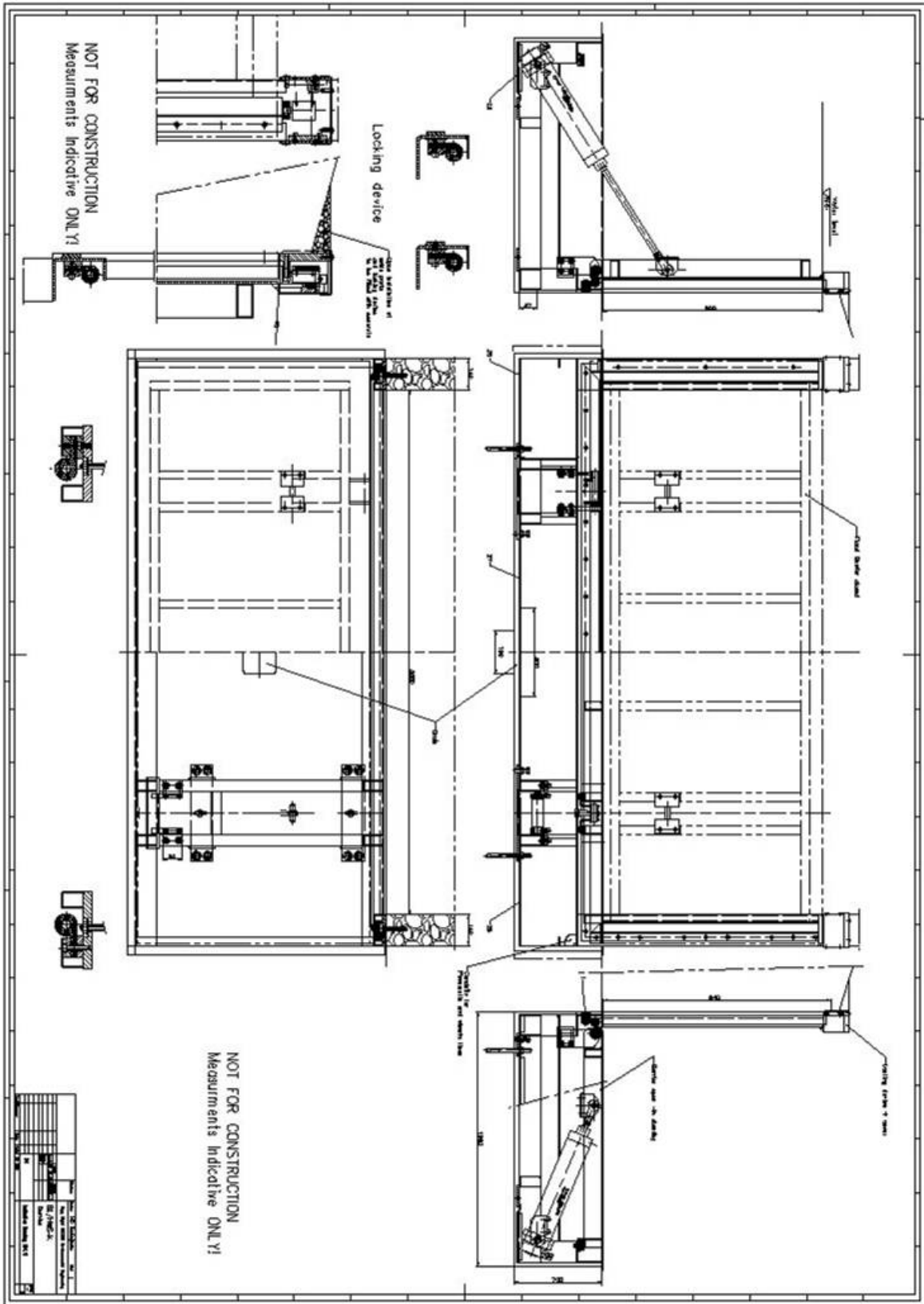

### 1.3 Description for Electrical Control Unit ©

The electrical control unit housing has the following dimensions, 380 x 380 x 230mm however, the dimensions can vary. Usually a Rittal housing is used.

The units main input is 110V/60Hz max 10A or 230V/50Hz max 10A pre fuse.

The unit is designed to take 3 normally closed contacts, which are classified as S100, main contact from fire control system, 24VDC max 4A, S101 reserve 24V DC max 4A, S102 reserve 24VDC max 4A. (3x1mm<sup>2</sup>)

The E-Box relays and transforms the input signal or signal's from the fire control switch board or any leakage detector to a permanent 24V signal. This signal is applied to the 24V DC solenoid valve in the pneumatic control unit. Once the unit receives a command from the from the fire control system or water sensor, it will then drop the permanent connection to the solenoid. This will then trigger the pneumatic barrier.

The system is designed to be failsafe. Should the permanent 24V signal to the pneumatic control unit be interrupted, e.g. through a power failure, this will initiate and close the barrier.

The electric control unit does not provide or handles any feedback signals from when the barriers are closed. The unit is designed to manage various input signals and put these forward to the pneumatic operated barrier.

FEAS power back up. (if provided)

This back up provides the power for the electronic control unit for up to 2 – 3 hours. If not in use, the power back up is being recharged.





1.4 Operating manual:  
**Blobel Flood Barrier BL/HWS-K**

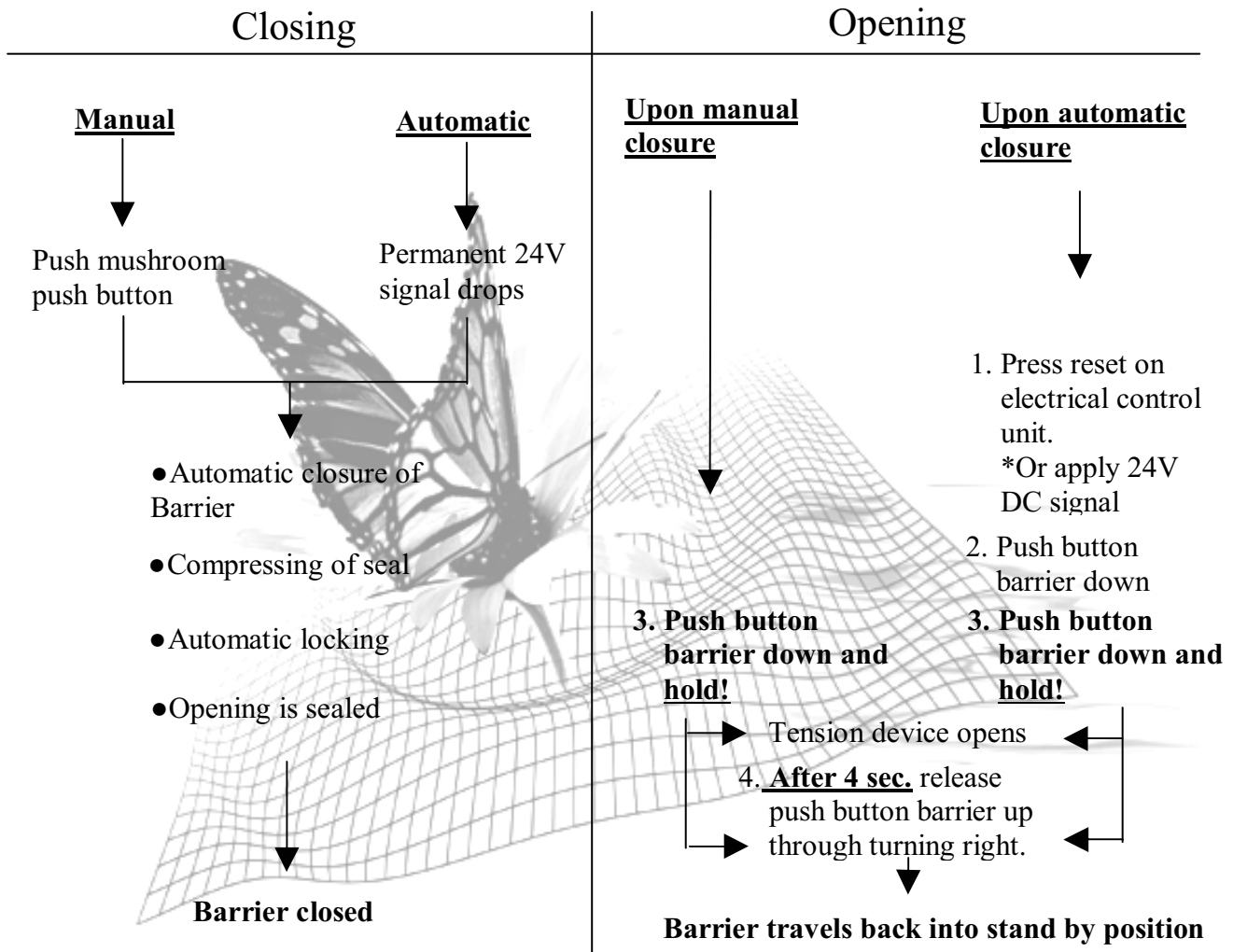
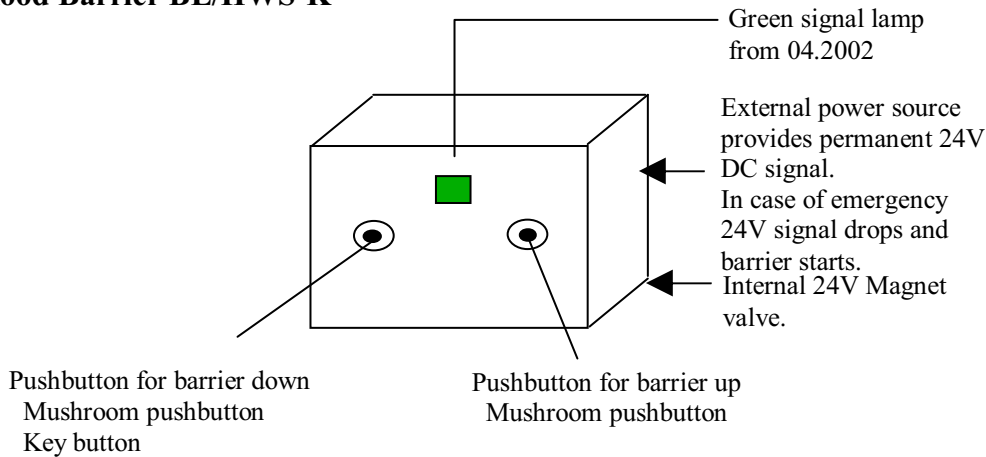

**Attention:**

1. Barrier operating area has to be clear of obstacles
2. Free movement of barrier has to be guaranteed. No clamping, or chaining.

\*The permanent 24V DC signal, which drops in case of an emergency, is supplied by an electrical control unit. Is the signal provided directly from a fire control box, then the control unit is not needed.



## 1.5 Pneumatic and electric circuit diagrams

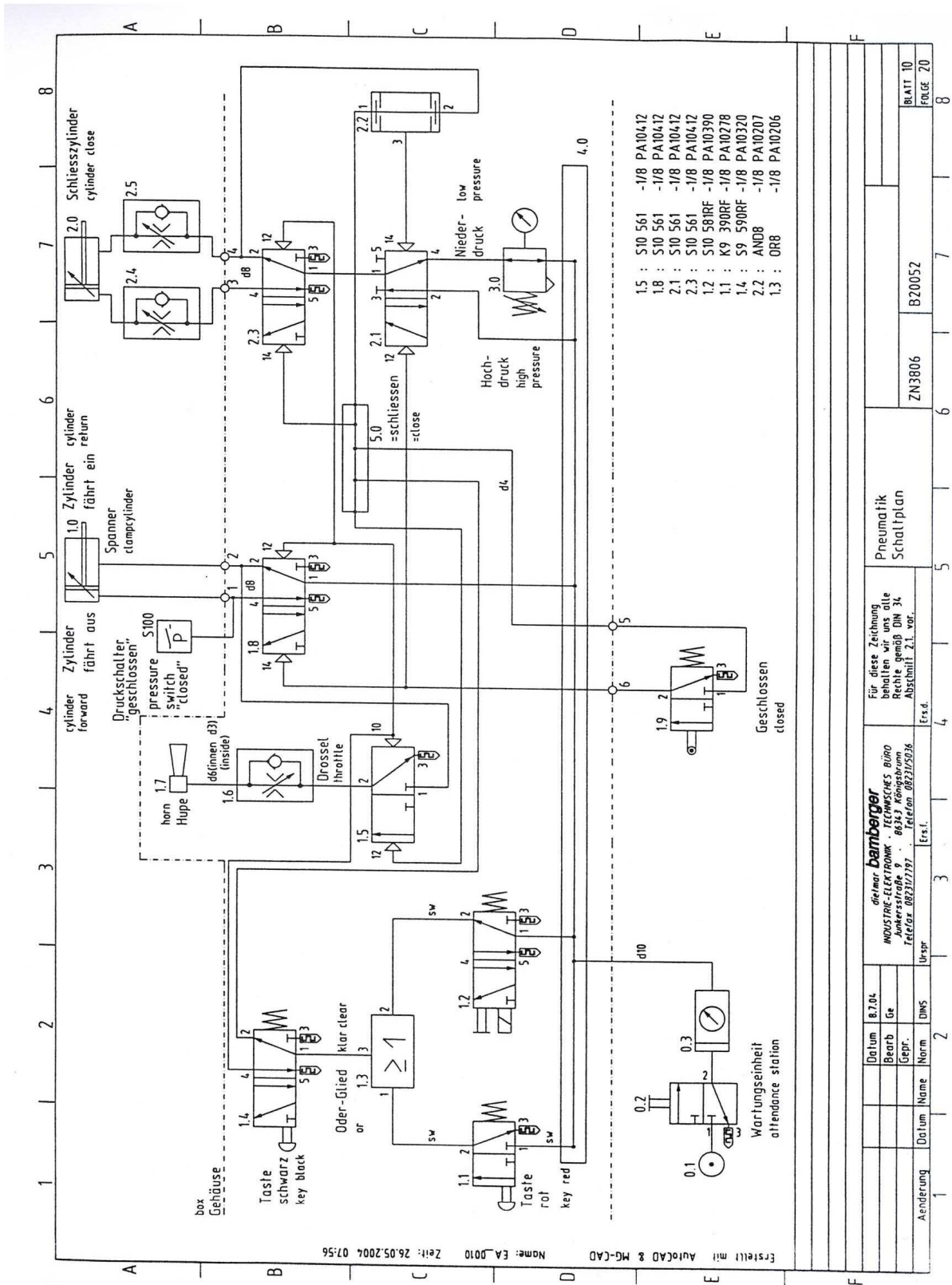

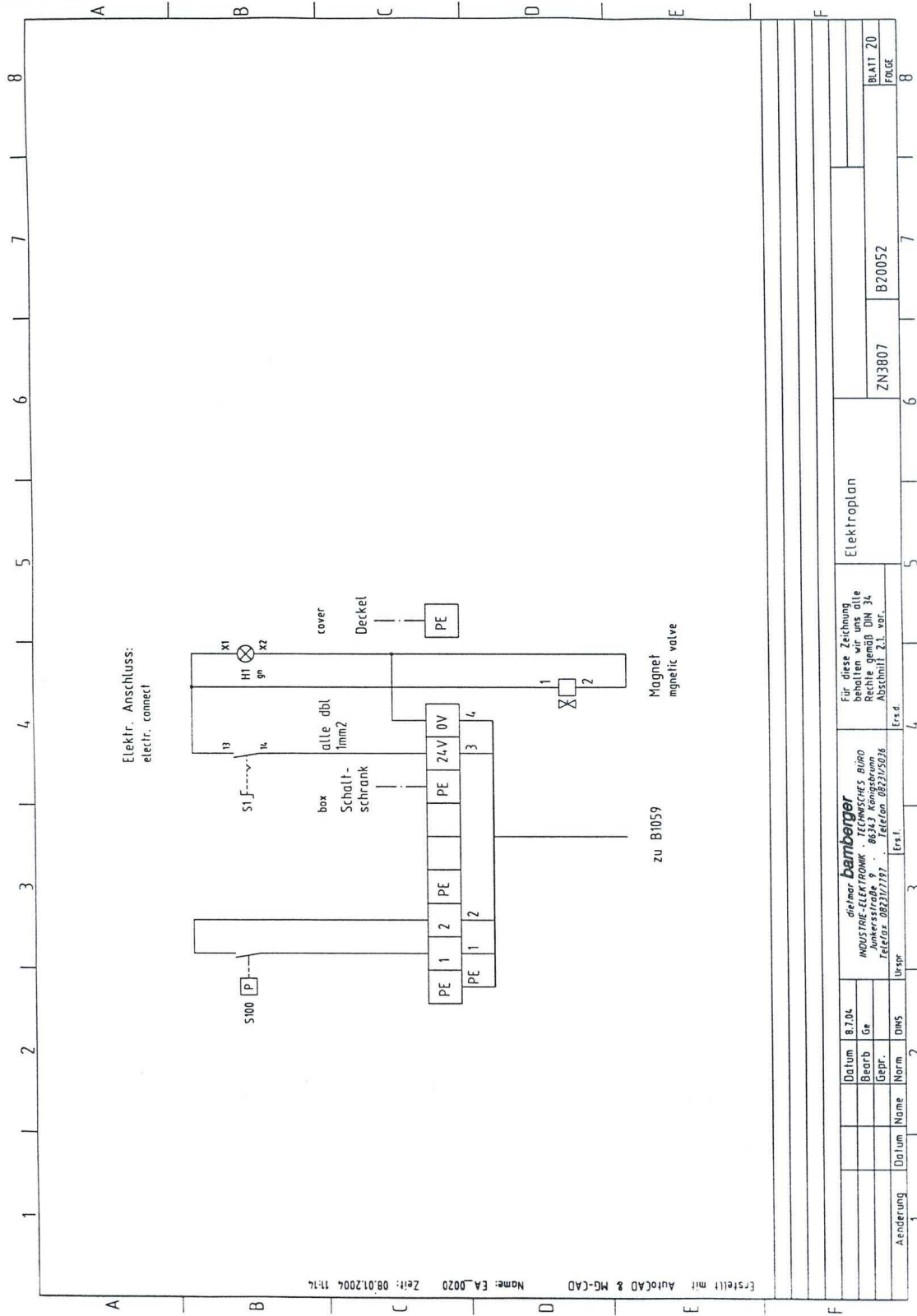

Aenderung		Datum	Name	Urspr		Ers.f.	
				Norm	DWS		
Datum	8.7.04						
Bearb	Ge						
Gepr.							
<b>diemer bamberger</b> INDUSTRIE-ELEKTRONIK - TECHNISCHES BÜRO Junkersstraße 9 · 06343 Königshamn Telefon 08231/7197 · Telefax 08231/5076							
Für diese Zeichnung behalten wir uns alle Rechte gemäß DIN 34 Abschnitt 2.1. vor.							
Elektroplan				ZN3807	B20052	BLATT 20 FOLGE	



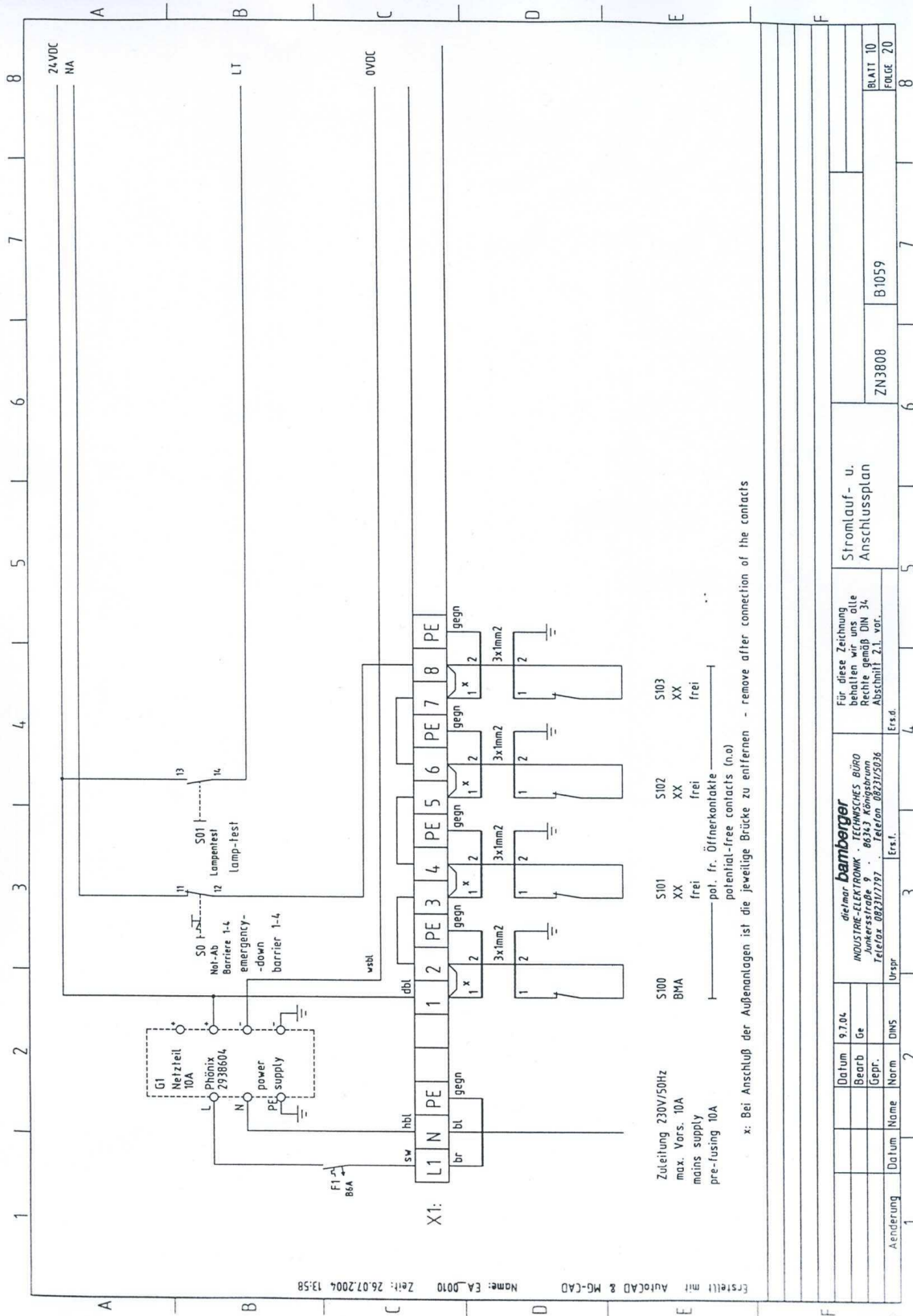

## 2.0 ISO 9001







Every BL/HWS- K is assembled and tested before shipping



## Our Field-Proven Barriers are Available in the Following Basic Designs

### **External Fast Closing Device**

In the event of a flood or emergency the barrier bodies are placed into mounts installed either in front of, or within, the opening and then pressed against the ground by means of external tensioning levers.



### **Fast Closing Devices Mounted on Barrier Body**

In the event of a flood or emergency the barrier bodies are placed into mounts installed either in front of, or within, the opening and then pressed against the ground by means of closing devices mounted on the barrier body.



### **Fast Closing Device Stackable System**

Two or more barrier bodies are placed into mounts installed either in front of or within the opening. These are pressed against the guiding rails and the ground by means of closing devices mounted on the barrier body. Guiding rails and barrier bodies are fitted with seals.



### **Traditionally Bolted**

The barrier body is placed into narrow mounting devices and pressed against the ground with tommy screws. Guiding rails and barrier bodies are fitted with seals.



### **Stackable System Traditionally Bolted**

Two or more barrier bodies are placed into narrow mounting devices and pressed against guiding rails and the ground with tommy screws. Guiding rails and barrier bodies are fitted with seals.



### **Flood Protection Wall Stackable with Tommy Screws**

One or more barrier body is placed into mobile or permanently fixed double U-shaped steel columns. The barrier sections are pressed against guiding rails and the ground with tommy screws. Guiding rails and barrier bodies are fitted with seals.



### **Special Automatic Design**

Automatic barrier – operation on a gate-like principle



### **Channel Inflow Protection**

Suitable for Channel inflow or overflow protection. Horizontal or vertical installation.



### **Window Sealing Plates**

Aluminium plate or reinforced steel plate. Force is applied through special pressure rails or tensioning devices fitted on the plate.



### **Special Cases**

Angled alloy or reinforced steel plate. Ideal for windows and doors situated near corners.



# Blobel Environmental Engineering

## An Overview of our Barriers

		Design Types											Tensioning			Implementation			Safety														
		Economy	Completely mobile	Mobile barrier bodies	Stationary mounting devices	One barrier body	Several barrier bodies	Flood protection wall	Plane sealing plate	Angled sealing plate	Framed sealing plate	Special automatic design	Profile: 200 x 50 mm	Profile: 150 x 80 mm	Profile: 115 x 50 mm	Traditionally bolted	External fast closing devices	Fast closing, mounted on barrier body	Pressure rails	Directly bolted	Window sealing	Door sealing	In the field	Channel inflow/overflow protection	Extreme conditions	Special design upon request	Design tested *	Field tested	Quality controlled	Ease of handling			
Barrier Systems	Slide Insert	BL/HST			•	•	•									•										•	•	•	•	•	•		
		BL/HEX			•	•	•										•										•	•	•	•	•	•	
		BL/HTL			•	•	•											•									•	•	•	•	•	•	
		BL/HTL-TR			•	•	•											•									•	•	•	•	•	•	
		BL/HAP			•	•	•	•	•																			•	•	•	•	•	•
		BL/HAP eco	•	•	•	•	•	•							•			•											•	•	•	•	•
Barrier Systems	Stackable	BL/HTL-SB			•	•	•	•						•			•										•	•	•	•	•	•	
		BL/HTL-SB vario			•	•	•	•										•										•	•	•	•	•	•
		BL/HAP-SB			•	•	•	•	•																			•	•	•	•	•	•
		BL/HSW-SB			•	•	•	•	•																			•	•	•	•	•	•
Barrier Systems	Fixed	BL/HED					•	•									•										•	•	•	•	•	•	
		BL/HHS					•	•										•									•	•	•	•	•	•	
		BL/FAP-P			•	•																						•	•	•	•	•	•
		BL/FAP-PR			•	•																						•	•	•	•	•	•
		BL/FAP-W			•	•																							•	•	•	•	•
Sealing Plates		BL/FAP-WVR			•	•																					•	•	•	•	•	•	
		BL/SAP			•																							•	•	•	•	•	•

\* Design-tested: • Certification ○ Analogous testing

### The Right Design for Each Requirement

Flood protection demands real solutions that deliver safety and aesthetics.

BLOBEL Flood Protection Systems offer several barrier profile dimensions and we will advise you which profile is best suited for your project.

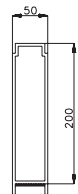

Standard profile  
200 x 50 mm

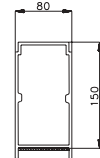

Standard profile  
150 x 80 mm

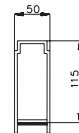

Special profile  
115 x 50 mm

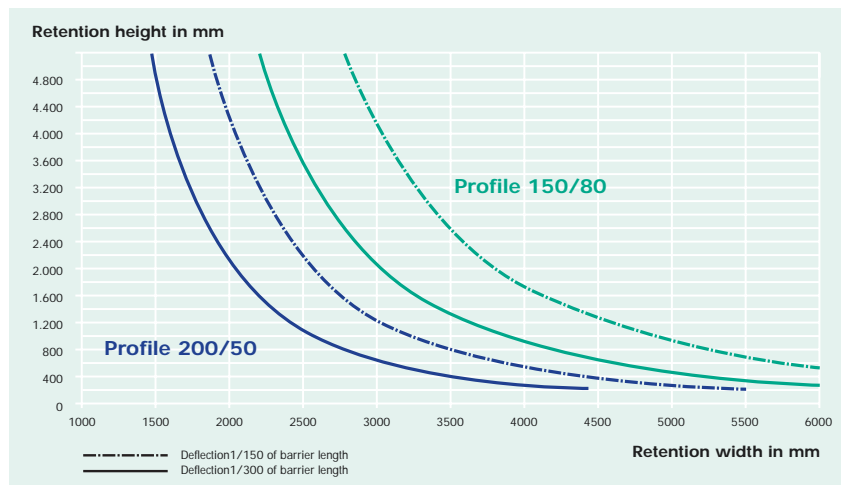

Maximum reliability with BLOBEL Flood Protection Systems.

In practise, our special designs have shown stability 1.5 – 3 times above average.

Static requirements are easily checked with the illustrated graph and BLOBEL underlines the high standard and safety of its Flood Protection Systems.

## Planning, Installation and Service

***Our consultation, planning and design services guarantee your system will comply in all aspects with legal requirements.***

Our engineering consultation services include:

- Site analysis and assessment
- Development of strategies for securing private and commercial assets
- Quality assurance and monitoring

***Delivery and installation by our professionals is an integral part of our service.***

You will receive all of the necessary certification after each installation.

- Conformity with local building specifications
- Test certificates if required
- Table of resistance for the seals
- CE conformity declaration

### **Spare Parts**

BLOBEL products are known for their highly robust nature. The stocking of spare parts for routine maintenance can therefore be limited primarily to wearing parts such as seals. Spare parts for all older designs are also available.

Our products are coordinated with one another, so special parts can also be integrated in existing product lines. Spare parts are conveniently available from the warehouse or with short notice delivery.



Your service representative

**BLOBEL Environmental Engineering LLC**  
270 Presidential Drive  
Wilmington, Delaware 19807

Tel: +1 302.353.1555  
Fax: +1 302.288.3753  
Email: [mail@blobel.us](mailto:mail@blobel.us)  
Web: [www.blobel.us](http://www.blobel.us)

### **Blobel Umwelttechnik GmbH**

Friedberger Strasse 4  
86453 Dasing, Germany

Phone: +49 (0)8205/96 07-0  
Fax: +49 (0)8205/96 07-20  
E-mail: [info@blobel.de](mailto:info@blobel.de)

### **Blobel Environmental Engineering**

PO Box 61, Bondi Rd.  
Bondi NSW 2026  
Sydney, Australia

Phone: +61 (0)2 9369 3504  
Fax: +61 (0)2 8915 1627  
E-mail: [mail@blobel.de](mailto:mail@blobel.de)  
<http://www.blobel.de>